

executive

04



**ONE**  
collection

executive

04



**ONE**  
collection

# codutti

L'ufficio rappresenta la tua identità, il percorso che stai compiendo e i valori che ti accompagnano.

Comfort, tecnologia e funzionalità contribuiscono al tuo benessere e facilitano la riuscita delle attività che ti vedono protagonista nella vita lavorativa.

Noi di Codutti, dal 1954 artigiani e industriali insieme, creiamo soluzioni d'arredo per ufficio di alta gamma con l'attenzione e la cura frutto di oltre sessant'anni di esperienza nella produzione e nel design made in Italy, per le aziende, per gli studi professionali e i progetti contract, anche sui mercati internazionali.

Tutte le nostre collezioni – dagli arredi direzionali agli operativi, dalle sedute alle pareti divisorie – nascono dall'unione di artigianalità e innovazione tecnologica e si contraddistinguono dall'alto livello di qualità e cura del dettaglio propri del marchio Codutti.

La flessibilità per noi è un valore: prendiamo in carico i tuoi progetti e siamo al tuo fianco nel fornire soluzioni personalizzate che superano le tue aspettative.

Un ufficio unico e coinvolgente, che ti emoziona ogni giorno.

Your office shows who you are, what your journey is and your principles are.

Comfort, technology and functionality: all contribute to your wellness and make easier those tasks that see you as the main actor in your daily business life.

We at Codutti have been both craftsmen and industrialists since 1954; we create design solutions for the highline office, paying the attention for the detail we have learned from more than sixty years of experience with the made in Italy production and design.

It's for companies, for professionals and contract projects, also on global markets.

All our collections - from the executive to the operative office, from the chairs to the partition walls - are born from the union between craftsmanship and technology innovation, and stand out thanks to high quality level and care for details, which has always been the main distinction of the Codutti brand.

We believe flexibility is an added value: we take in your project requests and stand at your side to give you customized solutions that go beyond your expectations.

A unique appealing office that excites you day after day.

# INDICE

## 01



Walnut | Gunmetal

p. 8

## 02



Tabacco | Tangerine | Glass

p. 12

## 03



Vintage | Stone | Brick-red

p. 16

## 04



Stone | Tangerine | Glass | White

p. 20

## 05



Walnut | Brick-red | Cream

p. 24

## 06



Vintage | Gunmetal | Pink

p. 28

## 07



Tabacco | Brick-red | White | Glass

p. 32

## 08



Vintage | Tangerine | Blue | Glass

p. 36

# INDEX

## 09



Walnut | Pink | Glass | Sand

p. 40

## 10



Tabacco | Brick-red | Glass | White

p. 44

## 11



Vintage | Stone | Gunmetal | Pink

p. 48

# One

natura e design

One è la collezione di arredi per ufficio nata per portare natura e benessere nel vostro spazio di lavoro. Legno, vetro, acciaio, cuoio e pietra dalla caratteristica superficie semi-grezza sono la sintesi perfetta di un ambiente naturale. Tutti i materiali utilizzati nella produzione di One sono completamente naturali e riciclabili. I pannelli sono realizzati in fibra di legno riciclata con impiallaccio in legno naturale e tinti con vernici atossiche. Le parti estetiche ed alcuni elementi sono realizzati in pietra naturale estratta dalle cave del nord-est italiano che viene poi lavorata con cura da artigiani esperti. Gli elementi in vetro riflettono la luce e i colori come uno specchio d'acqua nella natura incontaminata. Le parti in acciaio donano luminosità agli arredi e con la loro solidità sorreggono gli elementi strutturali di One.

One is the office furnishing collection created to bring nature and wellness in your work space. Wood, glass, steel, leather and stone with a characteristic semi-rough surface are the perfect combination for a natural environment. All materials used in producing One are fully natural and recyclables. The panels are made in recycled wood fibre veneered in natural wood and painted with non-toxic paints. The decorative details and some of the elements are made in natural stone obtained from North-eastern Italian caves that are then processed with care by expert artisans. The glass elements reflect the light and colours like a mirror of water in pristine nature. The steel portions give light to the furnishing and with their solidity support the structural elements of the One collection.



01 WALNUT | GUNMETAL



Finiture | Finishes

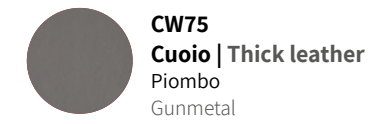
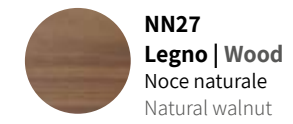

Libreria costituita da ante laterali e vano centrale disponibile con ripiano in vetro o in melaminico nero.

Bookcase with side doors and central open-front unit available with glass or black melamine shelf.

Dati Tecnici | Technical Data

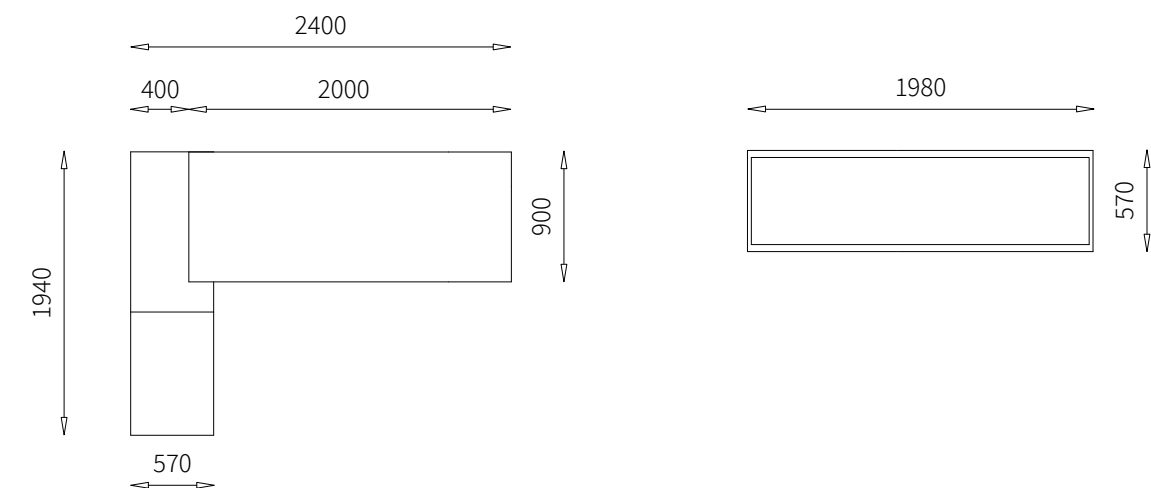

02 TABACCO | TANGERINE | GLASS





Finiture | Finishes

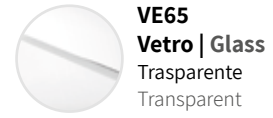
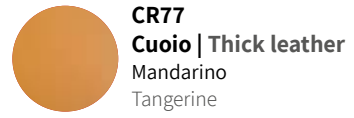
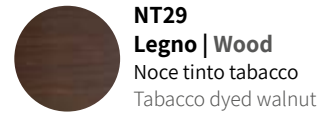

Dati Tecnici | Technical Data

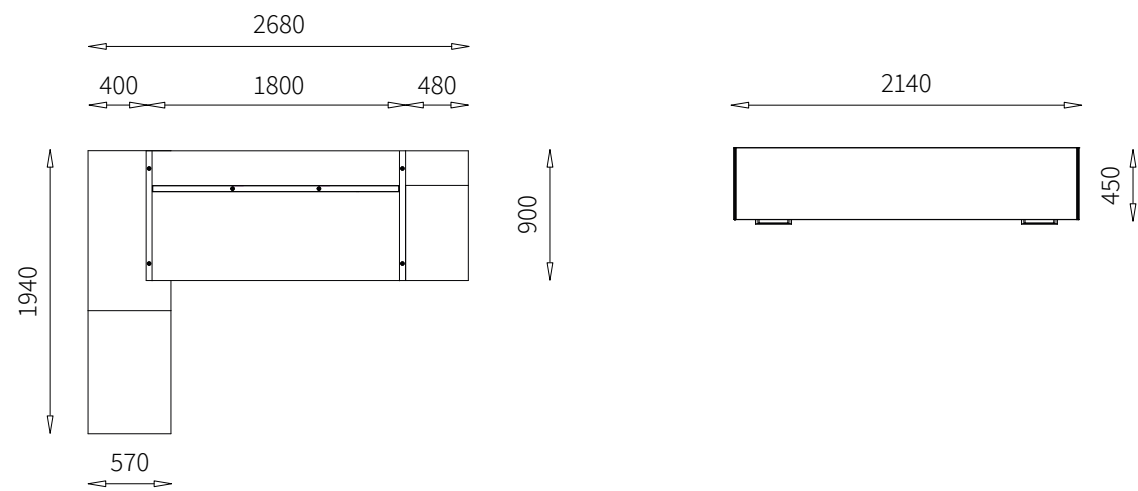

Allunghi modulari, disponibili in diverse combinazioni: cassettiere, mobiletti, portaborse, porta PC.

I ripiani interni possono essere in vetro o in melaminico nero.

Modular extensions, available in different combinations: drawer units, doors, bags or PC holder.

The internal shelves can be in glass or in black melamine.

03 VINTAGE | STONE | BRICK-RED



Finiture | Finishes

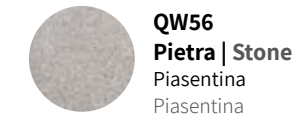
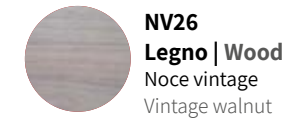

Fianchi in pietra Piasentina: spessore di 40 mm per quelli della scrivania e 18 mm nell'allungo.

The sides are in Piasentina stone: for desk are used 40 mm thick panels, for extension the panels are 18 mm thick.

Dati Tecnici | Technical Data

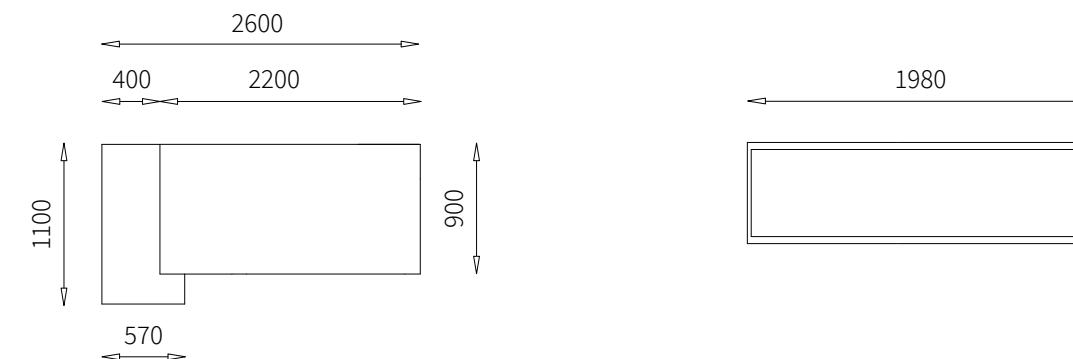

**04** STONE | TANGERINE | GLASS | WHITE



Finiture | Finishes



**QW56**  
Pietra | Stone  
Piasentina  
Piasentina



**CR77**  
Cuio | Thick leather  
Mandarino  
Tangerine



**VE65**  
Vetro | Glass  
Trasparente  
Transparent



**MB29**  
Melaminico | Melamine  
Bianco  
White

Dati Tecnici | Technical Data

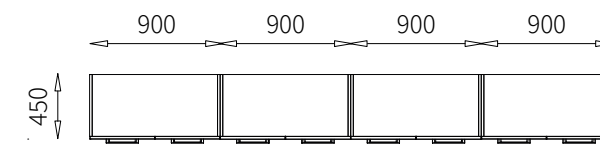
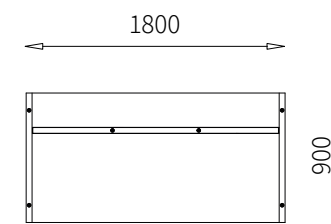

Top in vetro extrachiaro da 12 mm con  
traversa strutturale in acciaio inox lucido.  
12 mm extra-clear glass top with polished  
stainless steel structural beam.

05 WALNUT | BRICK-RED | CREAM



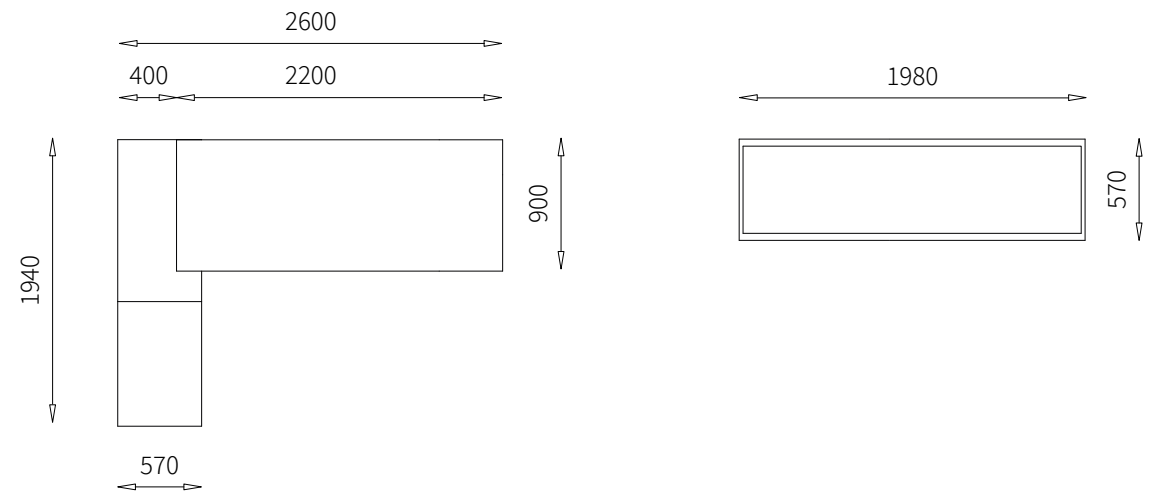

Finiture | Finishes

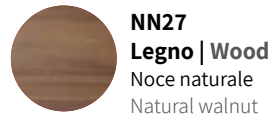

Cassettiera con sponde in metallo verniciato, schiena in legno e fondo in melaminico nero, guide quadro a sfera a rientro ammortizzato e cassettiere antiribaltamento.

Drawer unit with painted metal sides, back and bottom in black melamine, quadro guides with soft closure, equipped with simultaneous closing of all drawers and anti-tilt system.

06 VINTAGE | GUNMETAL | PINK





Dati Tecnici | Technical Data

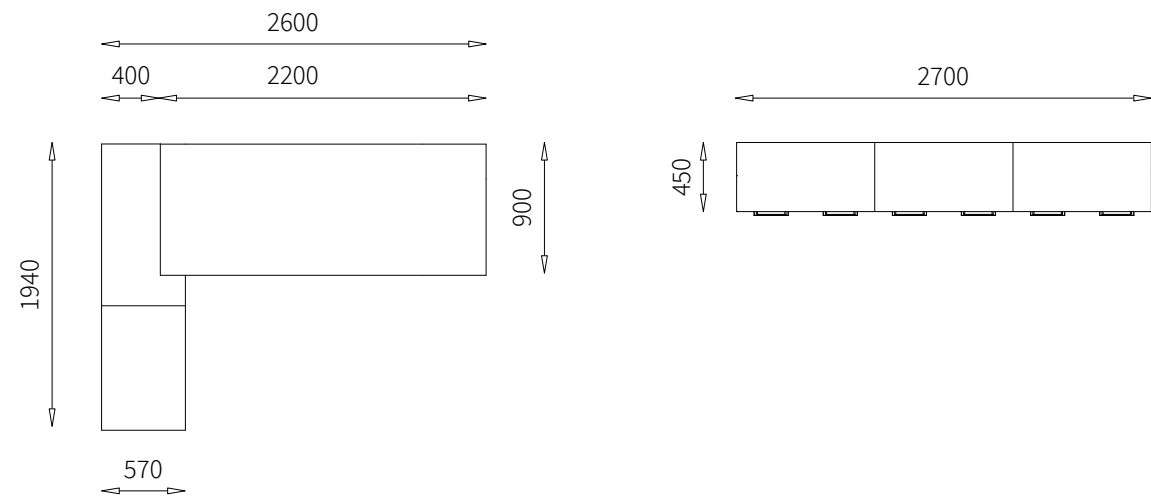

Finiture | Finishes

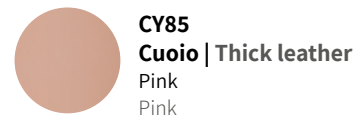
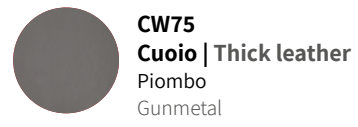

**A** Sottomano in cuoio intarsiato nel top della scrivania.  
 Deskpad in leather inlaid on the top.

**B** Paragambe in medium density rivestito in cuoio con cuciture a punto sella.  
 Back panel in medium density covered in saddle-stitched thick leather.



07 TABACCO | BRICK-RED | WHITE | GLASS



Dati Tecnici | Technical Data

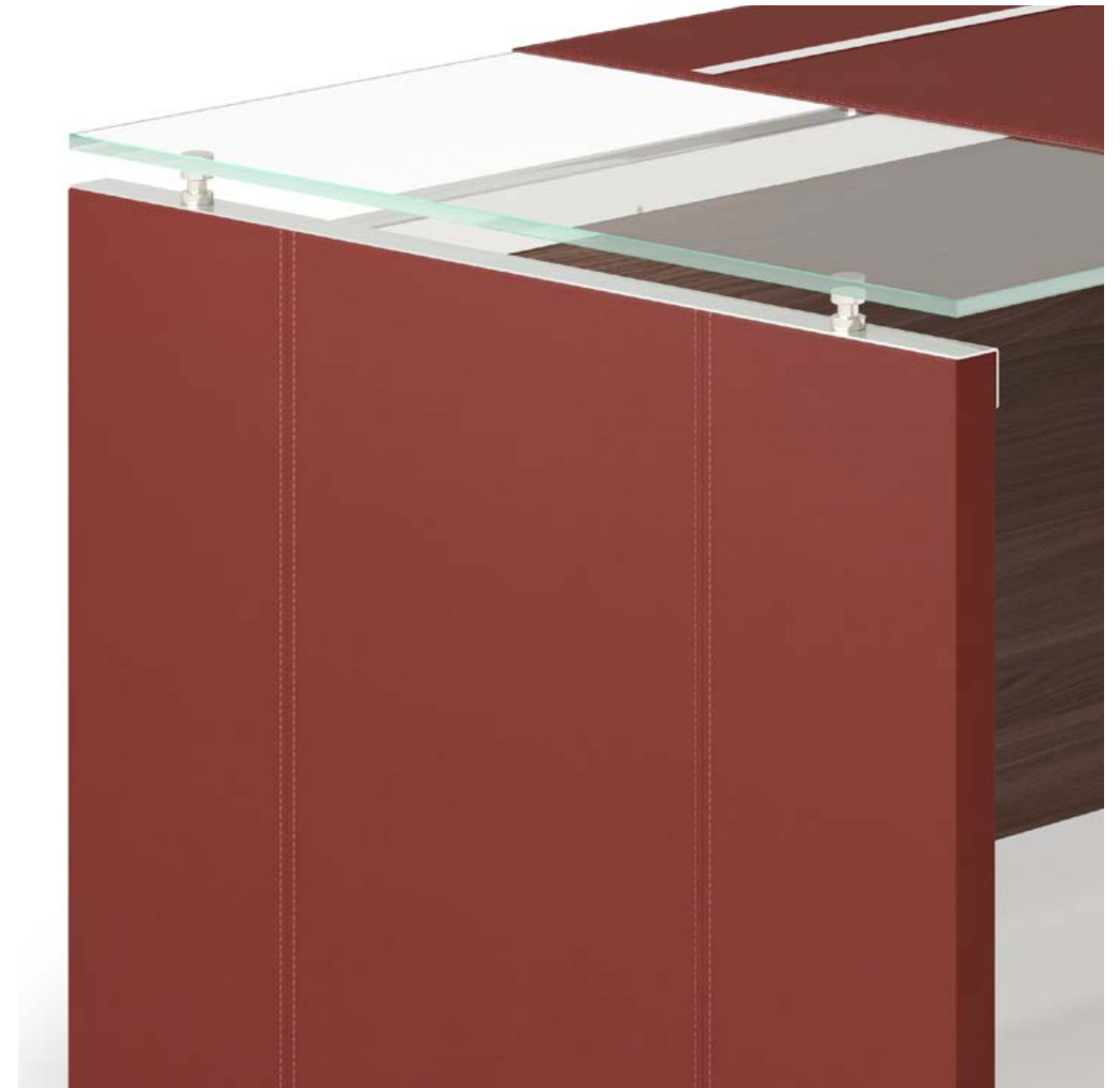
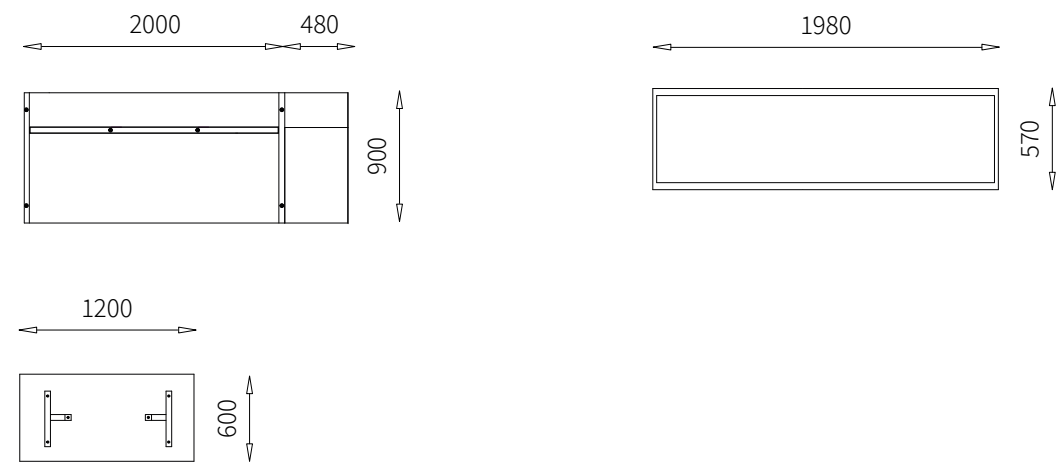

Fianchi rivestiti in cuoio con cucitura a punto sella.  
Sides covered in leather with saddle stitching.

Finiture | Finishes

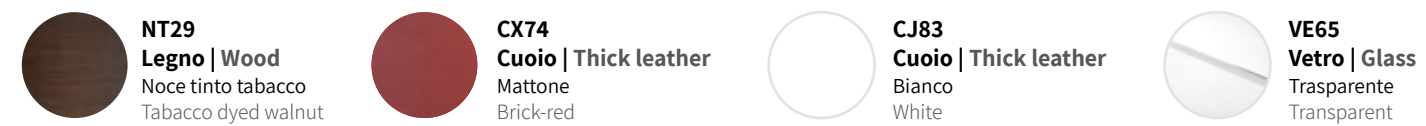

J8 VINTAGE | TANGERINE | BLUE | GLASS





Flange in acciaio inox per il fissaggio del vetro su fianchi in legno, cuoio e pietra.

Stainless steel flanges to fixing glass on wood, leather or stone sides.

Dati Tecnici | Technical Data



Finiture | Finishes

- 

**NV26**  
**Legno | Wood**  
Noce vintage  
Vintage walnut
- 

**CR77**  
**Cuoio | Thick leather**  
Mandarino  
Tangerine
- 

**CZ73**  
**Cuoio | Thick leather**  
Blu  
Blue
- 

**VE65**  
**Vetro | Glass**  
Trasparente  
Transparent



Tavoli riunione componibili: top combinati con l'impiego di diversi materiali quali vetro e legno, canalizzabili con intarsio in cuoio.

Modular meeting tables: tops combined with the use of different materials such as glass and wood, ducted with leather inlay.



**Dati Tecnici | Technical Data**

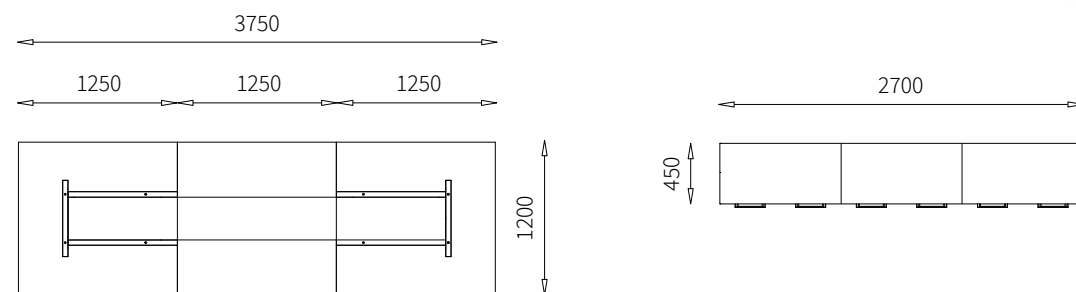

**Finiture | Finishes**

- 

**NN27**  
**Legno | Wood**  
Noce naturale  
Natural walnut
- 

**CY85**  
**Cuoio | Thick leather**  
Pink  
Pink
- 

**VE65**  
**Vetro | Glass**  
Trasparente  
Transparent
- 

**FS60**  
**Laccato | Lacquered**  
Sabbia  
Sand

**10** TABACCO | BRICK-RED | GLASS | WHITE





Dati Tecnici | Technical Data

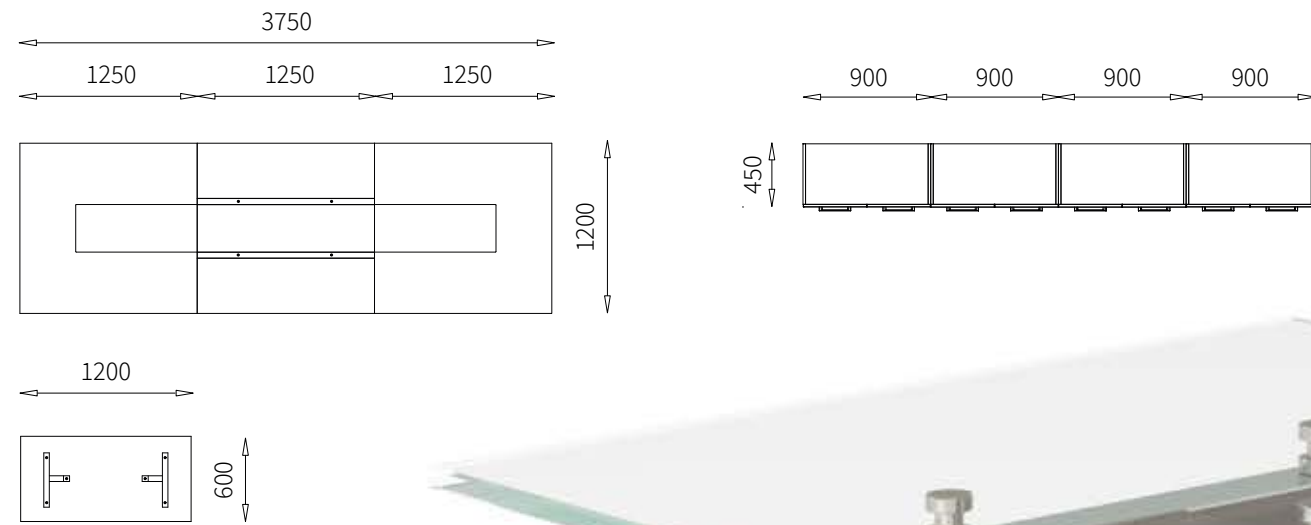

Finiture | Finishes

- NT29** **Legno | Wood**  
Noce tinto tabacco  
Tabacco dyed walnut
- CX74** **Cuoio | Thick leather**  
Mattone  
Brick-red
- VE65** **Vetro | Glass**  
Trasparente  
Transparent
- FB53** **Laccato | Lacquered**  
Bianco  
White



Tavolino disponibile in varie combinazioni di materiali: top in legno o vetro, base a T in legno, pietra o cuoio.

Side table available in various combinations of materials: wooden or glass top, wood, stone or leather T-shaped base.

**11** VINTAGE | STONE | GUNMETAL | PINK



Dati Tecnici | Technical Data

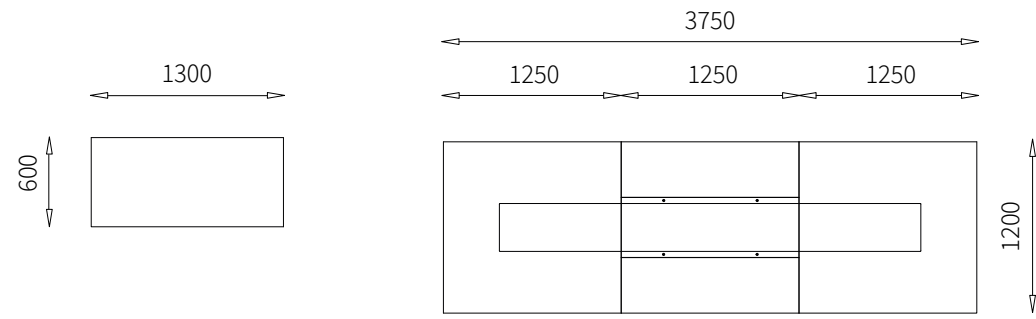

Finiture | Finishes

- 

**NV26**  
**Legno | Wood**  
Noce vintage  
Vintage walnut
- 

**QW56**  
**Pietra | Stone**  
Piasentina  
Piasentina
- 

**CW75**  
**Cuoio | Thick leather**  
Piombo  
Gunmetal
- 

**CY85**  
**Cuoio | Thick leather**  
Pink  
Pink

Tavolo attesa con fianchi in cuoio o legno, top in legno, traversa strutturale e tubo poggiapiedi in acciaio inox lucido. Altezza di 110 cm.

Waiting table with sides in leather or wood, wooden top, structural beam and footrest in polished stainless steel. Height of 110.



- 1** Portapenne  
Pen holder
- 2** Portacarte  
Paper tray
- 3** Tagliacarte  
Paper knife
- 4** Portabiglietti e porta telefono  
Cards and phone holder
- 5** Posacenere  
Ashtray
- 6** Portafoto  
Photo frame
- 7** Lampada tecnica da tavolo  
Technical desk lamp
- 8** Lampada paralume  
Desk lampshade
- 9** Appendiabiti  
Coat stand
- 10** Lampada da terra  
Floor lamp
- 11** Frigorifero  
Built-in refrigerator
- 12** Cassaforte  
Built-in safe

# Rainbow

I colori ed i loro abbinamenti esprimono chi sei. Poterli scegliere significa trovare la libertà di esprimersi e l'occasione di trasmettere un messaggio a chi ti circonda. Rainbow è il progetto che permette di personalizzare il colore di ogni collezione scegliendo tra le numerose finiture di cuoio previste nel Campionario Finiture Codutti.

The colours and the way they are matched tell who you are. Being able to choose them means having the freedom to express yourself and the chance to send a message to those around you. Rainbow is the project which permits personalizing the colour of every collection, choosing from among the numerous leather finishes in the Codutti Sample Book.

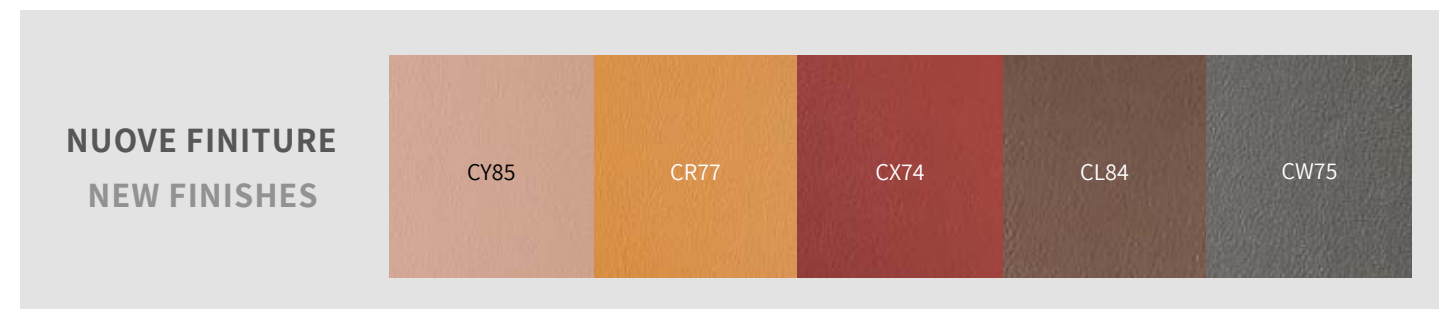

**Legno | Wood**

**NN27**  
Noce naturale | Natural walnut



**NV26**  
Noce vintage | Vintage walnut



**NT29**  
Noce tinto tabacco | Tabacco dyed walnut



**Cuoio | Leather**



**CW75**  
Piombo | Gunmetal



**CX74**  
Mattone | Brick-red



**CR77**  
Mandarino | Tangerine

**Vetro | Glass**

**VE65**  
Vetro trasparente | Transparent glass



**Pietra | Stone**



**QW56**  
Piasentina | Piasentina

**Il legno presente nelle collezioni direzionali Codutti è un materiale naturale. Per questo motivo differenze nelle caratteristiche cromatiche e di venatura presenti in ogni singolo elemento d'arredo, sono considerati segni distintivi di pregio.** Il cuoio e la pelle sono materiali diversamente trattati, quindi diversa è la rifrazione della luce che determina il tono del colore. Le cuciture di pelle e cuoio possono presentare irregolarità nel tratto e variazioni di linea. Pertanto differenze di tono del colore e lievi imperfezioni nelle cuciture devono essere accettate quale segno dell'unicità e della cura artigianale del prodotto. Codutti Furniture S.r.l. si riserva di apportare qualsiasi modifica alle Collezioni presenti in questo catalogo ogni volta che lo ritenga opportuno. La caratteristica della pietra Piasentina è l'unicità della fiammatura bianca che si crea naturalmente su ogni pezzo rendendolo esclusivo ad ogni composizione acquistata.

**The wood in Codutti's executive collections is natural material. Any differences in terms of color and veining between individual pieces of furniture are therefore considered as characteristic and distinctive markings.** Thick leather and thin leather undergo different curing processes. As a result, the surfaces refract light differently and this determines a variation in the shade of the color. Moreover, the stitching in both thick and thin leather may appear irregular. Any differences in the shade of color and slight imperfections in the stitching are the natural consequence of the craftsmanship involved in the manufacturing process, which makes each product unique. Codutti Furniture S.r.l. is entitled to bring any modifications on Collections included in this catalogue at any time, without previous notice. The characteristic of Piasentina stone is the uniqueness of the white flames veining that is naturally made on each piece making it exclusive in every composition bought.

SCRIVANIE | DESKS

Top legno | Wood top

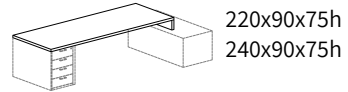
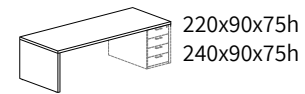
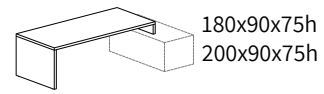
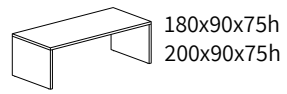

Top legno con intarsio | Inlaid wood top

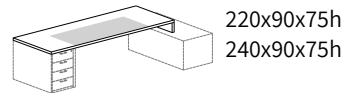
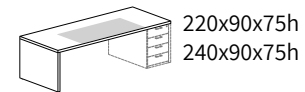
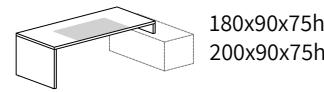
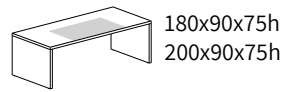

Top vetro trasparente | Transparent glass top

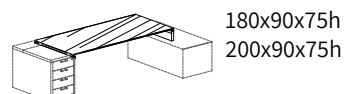
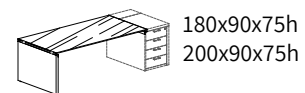
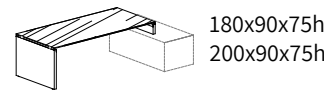
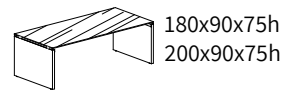

ALLUNGHI | EXTENSIONS

Ripiano in melaminico | Melamine shelf

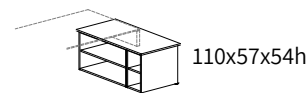
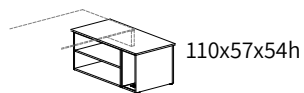

Ripiano in vetro trasparente | Transparent glass shelf

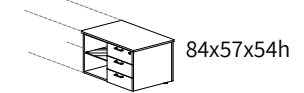
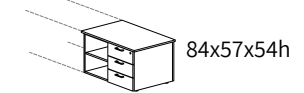
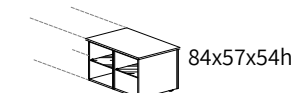
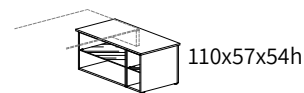
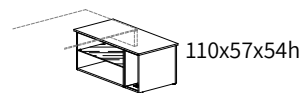

CASSETTIERE | DRAWER UNITS



TAVOLINI ATTESA | SIDE TABLES

Top legno | Wood top

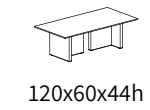

Top vetro trasparente | Transparent glass top



LIBRERIE | BOOKCASES

Ripiano in legno | Wood shelf

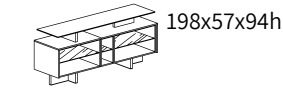
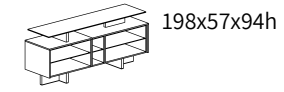

Ripiano in vetro trasparente | Transparent glass shelf

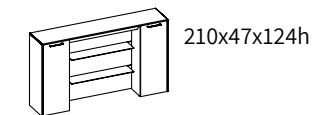
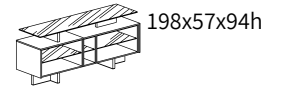
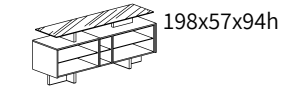

TAVOLI RIUNIONE | MEETING TABLES

Top legno | Wood top

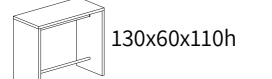
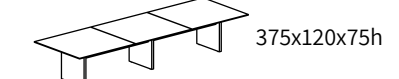
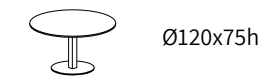

Top vetro trasparente | Transparent glass top



ARMADI | CABINETS

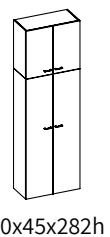
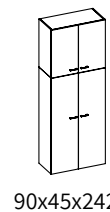
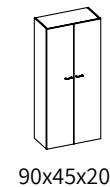
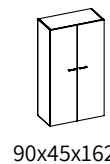

## codutti

**SCHEDA TECNICA One SCRIVANIE E TAVOLI**

Le scrivanie ed i tavoli sono composti da fianchi pannellati di 41 mm di spessore, realizzati in 3 distinte varianti, pietra, impiallacciato in legno noce americano tinto o rivestiti in cuoio.I fianchi sono collegati fra di loro da robuste traverse realizzate in acciaio inox lucidato a specchio e sono predisposti per l’installazione di piani in vetro trasparente extrachiaro di 12mm di spessore o in impiallacciato noce, tinto naturale, tabacco o sbiancato vintage da 41mm di spessore.Le traverse sono sagomate per ospitare uno schienale in legno impiallacciato in essenza noce o rivestito in cuoio e per poter consentire una gestione funzionale dei vari cavi elettrici. Nelle scrivanie, i fianchi pannellati laterali possono essere sostituiti da allunghi multifunzione su piedini regolabili o da pratiche cassettiere con intercapedine frontale per vano segretaria.

##### ALLUNGHI

Le scrivanie possono essere dotate lateralmente di due tipi di allungo. Il primo è un allungo multifunzione, realizzato in melaminico nero da 18mm di spessore con ripiani in vetro trasparente e in melaminico, attrezzabile con cassettiere a 3 cassette e mobiletti con ante, singole o doppie, porta unità computer o portaborse. La seconda tipologia prevede una cassetteria a 4 cassette, guide quadro a rientro ammortizzato, cassetto tipo cucina con eleganti sponde in metallo color antracite, fondo e schienale in melaminico nero, chiusura simultanea dei 4 cassette e dispositivo antiribaltamento. Controapposta ai frontali si trova una ante invisibile con apertura push-pull che racchiude un vano secretoria dotato di ripiano in nobilitato.Entrambe le configurazioni possono essere adottate singolarmente o simultaneamente. In entrambi i casi le strutture sono in melaminico nero mentre ante, frontali e schienali sono in legno impiallacciato noce tinto nelle colorazioni naturale, tabacco o sbiancato vintage. Controifianchi e top possono essere scelti fra pietra, cuoio o legno impiallacciato.

##### CASSETTIERE

Le cassettiere di One presentano una struttura in melaminico nero da 18mm, schienali e frontali in legno e top di finitura nelle 3 varianti, ossia pietra, legno o rivestito in cuoio. I cassettei tipo cucina, sono costituiti da guide quadro a rientro ammortizzato, eleganti sponde in metallo color antracite, fondo e schienale in melaminico nero, chiusura simultanea dei 3 o 4 cassette e dispositivo antiribaltamento. La versione con cassetto schedario è prevista solo a richiesta. Le cassettiere poggiano su 4 ruote piroettanti e sono impreziosite da eleganti maniglie in metallo cromato.

##### LIBRERIE

Le librerie sono disponibili nelle stesse finiture di scrivanie ed allunghi. Sono composte da una serie di mobiletti a giorno con ripiano in vetro o in melaminico, rialzati da terra tramite fianchi pannellati in legno, pietra o cuoio. Le ante, dotate di chiusura ammortizzata,con o senza serratura, sono opzionali e sono costruite in legno noce impiallacciato naturale, vintage o tinto tabacco. Top e controifianchi di finitura sono disponibili nelle 3 varianti: pietra, legno o cuoio con cucitura a punto sella. La mensola soprano appoggia su distanziali in pietra, legno o cuoio.

##### ARMADI

Numerose possibilità compositive caratterizzano gli armadi modulari, con larghezza di 90 cm e altezza 80 - 120 - 160 - 200 - 240 - 280 cm. I top di finitura sono a tutta larghezza, con spessore 19mm in legno noce tinto nelle tre finiture della scrivania. Le ante sono montate su cerniere con apertura a 110° e dotate di chiusura soft-close. Oltre alle finitura in legno, le ante, sono disponibili in vetro temprato trasparente da 4 mm, con telajo in alluminio lucido. I cassettei schedario alloggiati all'interno delle ante montano un telaio in acciaio verniciato, scorrono su guide telescopiche a sfera e presentano di serie chiusura soft e sistema antiribaltamento. Le serrature sono a semi cariglione e non sono previste per le ante in vetro. I ripiani interni in nobilitato melaminico hanno uno spessore di 25 mm mentre gli schienali da 8 mm hanno la stessa finitura dei fianchi per un possibile utilizzo anche a centro stanza. Gli armadi poggiano su piedini registrati dall'interno e sono predisposti all'unione laterale. Per motivi di sicurezza, tutti gli armadi che contengono cassettei schedario, se usati singolarmente, devono essere assicurati a una parete di sostegno.

##### COMPLEMENTI

Come nello stile Codutti, anche la Linea Direzionale One presenta una serie di accessori che si abbinano con eleganza alle caratteristiche della collezione. Le parti in metallo, sono cromate o in acciaio inox lucidato a specchio con inserti in pietra Piasentina. Le lampade presentano una gamma di colori per i paralumi in peretta

cromia con i cuoi utilizzati nella collezione. In alternativa si possono utilizzare gli accessori della Linea Attiva che si integrano altrettanto bene con la Linea One.

##### One SPECIFICATIONS DESKS AND TABLES

The desks and tables are made of 41 mm thick panelled sides in 3 versions: stone, painted veneered American walnut wood or upholstered in leather. The sides are connected to each other with sturdy crossbars in mirror-polished stainless steel and are set-up for the installation of 12 mm extra-clear glass tops or veneered walnut wood, painted in natural colour, tobacco colour or faded vintage colour with a thickness of 41mm. The crossbars are shaped in such a way as to hold a veneered back in walnut wood or upholstered in leather and to allow the practical management of the electrical cables. For the desks, the panelled lateral sides can be replaced with multi-functional extensions on adjustable feet or practical drawers with front gap for the secretaire compartment.

##### EXTENSIONS

The desks can be equipped laterally with two types of extensions. The first one is a multi-functional extension, manufactured in 18 mm thick black melamine with shelves in clear glass or in melamine. It can be equipped with 3 drawers and cabinets with doors, either single or double door, PC-holder units or bag-holders. The second type includes a 4-drawer unit, square guides with soft-close, kitchen-style drawer with elegant sides in anthracite-coloured metal, bottom and back in black melamine, simultaneous closing of the 4 drawers and anti-tilt device. Opposite to the fronts, there is an invisible door with push-pull opening that includes a secretai-re compartment equipped with a wooden shelf. Both configurations can be equipped individual-ly or simultaneously. In both cases, the frames are in black melamine, while doors, fronts and backs are in veneered walnut wood painted in natural colour, tobacco colour or faded vintage colour. Sides and tops can be chosen among stone, leather or veneered wood.

##### DRAWER UNITS

The One collection's drawer units feature a frame in 18 mm thick black melamine, back and front in wood and finishing top in three different versions: stone, wood or upholstered in leather. The kitchen-style drawers are equipped with soft-close square guides, elegant sides in anthracite-coloured metal, bottom and back in black melamine, simultaneous closing of the 3 or 4 drawers and anti-tilt device. The version with file cabinet is provided only on request. Drawer units have 4 swivelling castors and have elegant chromed metal handles.

##### BOOKCASES

Bookcases are available in the same finishes of the desks and extensions. They are made of a series of open cabinets with glass or melamine shelves, raised through panelled sides in wood stone or leather. The doors, with soft-closing system, with or without key-lock, are optional and are manufactured in veneered walnut wood painted in natural colour, tobacco colour or vintage colour. Top and sides are available in three different versions: stone, wood, or leather with saddle stitch. The top shelf rests on stone, wood or leather spacers.

##### CABINETS

Numerous possibilities characterize the modular cabinets, with a width of 90 cm and height of 80 - 120 - 160 - 200 - 240 - 280 mm. The finishing tops are full width, with a thickness of 19 mm in walnut wood available in the three desk finishes. The doors are hinged with a 110° opening radius and soft closing action. In addition to the wood finishing, the doors are available in 4mm thick tempered transparent glass and frame in glossy aluminium. The file cabinet drawers are located behind the doors and feature a black painted steel frame and slide on telescopic ball guides with soft closing and anti-tilt system. The locks are half-cremone bolts and are not for the glass doors. The internal shelves in veneered melami-ne have a thickness of 25 mm while the 8 mm backs have the same finishing of the sides for possible use also in the middle of the room. Cabinets have adjustable feet and can be joined to other units at the sides. For safety reasons, all single cabinets equipped with file cabinet drawers must be secured to a supporting wall.

##### ACCESSORIES

As in the Codutti style, also the One Directional line features a series of accessories that combine with elegance the characteristics of the collection. The metal elements are chromed or in glossy mirrored stainless steel with inserts in Piasentina stone. The lights feature a range of colours for the lamp shades that combine

perfectly with the leather used in the collection. Alternatively, accessories from the Attiva line can be used since they integrate just as elegantly with the One collection.

##### FICHE TECHNIQUE One BUREAUX ET TABLES

Les bureaux et tables are des tables se composent de panneaux latéraux de 41 mm d'épaisseur, réalisés en 3 différentes variantes : pierre, placés en bois de noyer américain peint, ou revêtu de cuir. Les côtés sont reliés entre eux par des traverses en acier inox poli effet miroir et sont prédisposés pour l'installation de plans en verre transparent ultra-clair de 12 mm d'épaisseur ou en noyer plaqué, dans les versions naturel, tabac ou blanc vintage, de 41 mm d'épaisseur. Les traverses sont façonnées pour accueillir un dossier en bois plaqué en essence de noyer, ou revêtu de cuir, et pour permettre le passage de plusieurs câbles électriques. Sur les bureaux, les panneaux latéraux peuvent être remplacés par des rallonges multifonctions, dotées de pieds réglables, ou par des tiroirs pratiques avec inter-stice frontal pour meuble secrétaire.

##### RALLONGES

Les bureaux peuvent être dotés latéralement de deux types de rallonges. La première est une rallonge multifonction en mélaminé noir, de 18 mm d'épaisseur avec des rayons en verre transparent ou en mélaminé, pouvant être équipée de caissons à 3 tiroirs et de meubles avec des portes, simples ou doubles, des porte-ordina-teurs ou des porte-sacs. La deuxième typologie prévoit un caisson à 4 tiroirs, des glissières car-rées et amorties, tiroir type cuisine avec d'élég-ants bords en métal couleur anthracite, fond et arrière en mélaminé noir, fermeture simultanée des 4 tiroirs et dispositif anti-basculement. À l'opposé des façades, on trouve une porte invisible avec ouverture push-pull qui renferme un secrétaire doté d'un plan en panneau de particules. Ces deux configurations peuvent être adoptées singulièrement ou simultanément. Dans les deux cas, les structures sont en mélamé-ine noir, tandis que les portes et les dossierers sont en bois de noyer plaqué peint dans les cou-leurs naturel, tabac ou blanc vintage. Les côtés et le plan peuvent être choisis dans les versions pierre, cuir et bois plaqué.

##### CAISSONS

Les caissons de One présentent une structure en mélaminé noir de 18 mm, des dossierers et des façades en bois et un plan en finition dans les 3 variantes en pierre, bois ou revêtement en cuir. Les caissons de cuisine sont constitués de glis-sières carrées et amorties, avec d'élégants bords en métal couleur anthracite, fond et dossierer en mélaminé noir, fermeture simultanée des 3 ou 4 tiroirs et dispositif anti-basculement. La version avec tiroir-classseur est disponible seulement sur demande. Les caissons sont posés sur 4 roues pivotantes et ils sont enrichis d'élégantes poi-gnées en métal chromé.

##### CRÉDENCES

Les crédenes sont disponibles dans les mêmes finitions que les bureaux et les rallonges. Elles se composent d'une série de meubles ouverts avec rayon en verre ou en mélaminé, rehaussées à l'aide de côtés en bois, pierre ou cuir. Les portes, dotées d'une fermeture amortie, avec ou sans serrure, sont en option et construites en bois de noyer plaqué en version naturel, vintage ou tabac. Les plans et les flanges de finition sont disponibles dans les 3 variantes : pierre, bois ou cuir avec couture en point de sellier. La base de rehaussement repose sur des entretoises en pierre, bois ou cuir.

##### ARMOIRES

Les armoires modulaires, d'une largeur de 90 cm et d'une hauteur de 80 - 120 - 160 - 200 - 240 - 280 cm sont caractérisées par de nombreuses possibilités de composition. Les plans de fini-tion sont sur toute la largeur, avec des épais-seurs de 19 mm en bois de noyer peint dans les finitions du bureau. Les portes sont montées sur des charnières permettant une ouverture à 110° et munies d'un système de fermeture soft. Outre les finitions en bois, les portes sont disponibles en verre transparent de 4 mm avec un cadre en aluminium brillant. Les tiroirs-classseu-rs logés à l'intérieur des portes, sont équipés d'un châssis en acier laqué noir, ils coulissent sur des glissières à billes telescopiques et pré-sentent, d'origine, une fermeture soft et un sy-stème anti-basculement. Les crémons-serrures ne sont pas fournies avec les portes en verre. Les rayons internes en particules de bois mélaminé ont une épaisseur de 25 mm, tandis que les dossierers de 8 mm ont la même finition que les côtés pour une éventuelle utilisation au centre de la pièce. Les armoires sont posées sur des pieds réglables de l'intérieur et sont disposées par la jonction latérale. Pour des raisons de sécurité, toutes les armoires utilisées individuel-

lement et contenant des tiroirs fichier doivent être fixées contre un mur de support.

##### COMPLÉMENTS

Comme toujours avec Codutti, la ligne direction-nelle One présente une série d'accessoires qui s'associent avec élégance aux caractéristi-ques de la collection. Les parties en métal sont chromées ou en acier inox poli effet miroir, avec des éléments en pierre Piasentina. Les lampes présentent une gamme de couleurs pour les abat-jours, dans les mêmes tons que ceux utili-sés dans la collection. En alternative, il est pos-sible d'utiliser les accessoires de la ligne Attiva qui s'accordent parfaitement avec la ligne One.

##### FICHA TÉCNICA One ESCRITORIOS Y MESAS

Los escritorios y las mesas se componen por laterales con 41 mm de grosor, creados en 3 variantes distintos: piedra, enchapado de ma-dera de nogal americano teñido o revestidos en cuero. Los laterales están unidos entre ellos por robustos travesaños realizados en acero inoxidable pulido tipo espejo y están prepara-dos para la instalación de superficies de vidrio transparente extralacro de 12 mm de grosor o enchapado de nogal, de color natural, tabaco o con un aclarado vintage de 41 mm de grosor. Los travesaños están perfilados para albergar una parte posterior de madera enchapada de ma-dera de nogal o revestimiento de cuero y para permitir una gestión funcional de los cables eléctricos. En los escritorios, los paneles latera-les se pueden sustituir por alas multifuncionales sobre unas patas ajustables o unas prácticas cajoneras con un espacio frontal tipo secreter.

##### ALAS PARA ESCRITORIOS

Los escritorios pueden dotarse de dos tipos de alas laterales. La primera es un ala multifuncio-nal realizado en melamina negra de 18 mm de grosor con estantes en vidrio transparente o de melamina a la que se le pueden añadir 3 cajones y muebles con puertas, individuales o dobles, extensión para el ordenador o para colocar tu bolsa. El segundo tipo de ala prevé una cajo-nera con 4 cajones, guías tipo cuadro con cierre amortiguado, cajón tipo cocina con elegantes bordes en metal color antracita, fondo y parte posterior en melamina negra, cierre simultán-ea de los 4 cajones y dispositivo antivuelco. De forma contrapuesta a los frentes hay una puerta invisible con abertura push-pull que alberga un compartimento secreter dotato de un estante en aglomerado. Ambas configuraciones se pue-den disponer de forma individual o simultánea. En ambos casos, las estructuras son de melami-na negra mientras las puertas, los frentes y las partes posteriores son de madera enchapada de nogal teñido en tonal natural, tabaco y aclara-do vintage. Los contralaterales y las superficies superiores están disponibles en piedra, cuero y madera enchapada.

##### CAJONERAS

Las cajoneras One se caracterizan por una estructura de melamina negra de 18 mm, frente y parte posterior de madera y parte superior con 3 acabados posibles: piedra, madera o revesti-do en cuero. Los cajones tipo cocina cuentan con guías tipo cuadro con cierre amortiguado, elegantes bordes de metal color antracita, fon-do y parte posterior en melamina negra, cierre simultáneo de los 3 o 4 cajones y dispositivo an-tivuelco. La versión con archivador solo está di-sponible en piel. Las cajoneras se apoyan sobre 4 ruedas giratorias y se han embellecido con elegantes tiradores de metal cromado.

##### ESTANTERÍAS

Las estanterías están disponibles en los mi-smos acabados que los escritorios y las alas de escritorios. Están compuestas por una serie de muebles abiertos con un estante de vidrio o me-lamina que se apoyan sobre unos laterales de paneles de madera, piedra o cuero. Las puertas, dotadas de cierre amortizado, con o sin cerradu-ra, son opcionales y están formadas por mader-a de nogal chapada natural, vintage o teñido ta-baco. La superficie superior y los contralaterales se presentan en 3 variantes diferentes: piedra, madera o cuero con pumtadas de talabartería. El estante saliente se apoya sobre espaciadores de piedra, madera o cuero.

##### ARMARIOS

Los armarios modulares ofrecen numerosas composiciones y están disponibles con una anchura de 90 cm y una altura de 80 - 120 - 160 - 200 - 240 - 280 cm. Las superficies superiores, de anchura total, presentan un grosor de 19 mm y están realizados en madera de nogal teñida en los tres acabados de los escritorios. Las puertas cuentan con bisagras con una abertura a 110º y están dotadas de cierre soft-close. Además de los acabados en madera, las puertas están disponibles en vidrio templado transparente por la jonction latérale. Pour des raisons de sécurité, toutes les armoires utilisées individuel-

con una estructura en acero pintado, se desli-zan por guías telescopicas de bola e incluyen cierre soft y sistema antivuelco. Las cerraduras incluyen una semibisagra y no están disponibles para las puertas de vidrio. Los estantes internos en aglomerado de melamina tienen un grosor de 25 mm, mientras que la parte posterior de 8 mm presenta el mismo acabado que los la-terales por si se quisiera utilizar de forma indi-vidual. Los armarios se apoyan sobre unos pies ajustables desde el interior y están prepara-dos para unirlos lateralmente. Por razones de segu-ridad, todos los armarios que contienen cajones archivadores, se ise usan individualmente, deben asegurarse a una pared de apoyo.

##### COMPLEMENTOS

Al igual que en el estile Codutti, la línea Dire-cional One también presenta una serie de accesorios que combinan con elegancia con las características de la colección. Las partes de metal están cromadas o en acero inoxidable pulido tipo espejo con inserciones en piedra piasentina. Las lámparas presentan una gama de colores para las pantallas con una perfecta coordinación cromática con los cueros de la colección. Como alternativa, se pueden utilizar los accesorios de la línea Attiva que se acoplan perfectamente con la línea One.

##### ТЕХНИЧЕСКИЕ ХАРАКТЕРИСТИКИ КОЛЛЕКЦИИ One ПИСЬМЕННЫЕ И ОФИСНЫЕ СТОЛЫ

Письменные и офисные столы состоят из панельных боковин толщиной 41 мм, выполненных в 3 различных вариантах: камень, шпонированный окрашенный древесный американского ореха либо обтяжка кожей. Боковины соединяются друг с другом прочными перекладными, выполненными из полированной зеркальной нержавеющей стали; на боковины монтируются столешницы из ультрасветлого прозрачного стекла толщиной 12 мм с столешницы толщиной 41 мм из шпона из древесины ореха, окрашенного в натуральный, табачный либо винтажный выбеленный цвет. В фигурные перекладины вставляен стеновая панель из шпона из древесины орехового дерева либо обтянутая кожей, для удобной проводки различных электрических кабелей. У письменных столов панельные боковины могут заменяться дополнительными многофункциональными удлинителями модулями на регулируемых опорных ножках либо практичными тумбами с ящиками, с фронтальной нишей для секретера.

##### ДОПОЛНИТЕЛЬНЫЕ МОДУЛИ

Письменные столы могут комплектоваться дополнительными боковыми модулями двух типов. Первый дополнительный модуль является многофункциональным, изготавливается из черного мелamina толщиной 18 мм, с полками из прозрачного стекла или мелamina; комплектуется тумбами с 3 выдвижными ящиками и тумбочками со створками, которые могут быть одинарными или двойными, а также полками для компьютера или сумок. Дополнительный модуль второго типа оснащен тумбой с 4 выдвижными ящиками, направляющими с амортизированным возвратом, выдвижным ящиком кухонного типа с элегантными металлическими бортиками антрацитового цвета, дном и стеновой панелью из черного мелamina; предусмотрена система одновременного закрытия 4 ящиков и антипрокидывать. Напротив фронтальной стороны смонтирована невидимая створка с нажимно-отжимной системой открытия, за которой расположена потайная ниша для секретера с полкой из кашированного мелamina. Обе конфигурации могут использоваться по отдельности либо одновременно. В обоих случаях каркасы выполняются из черного мелamina, а створки, фронтальные и стеновые панели - из шпона из древесины ореха, окрашенного в натуральный, табачный либо винтажный выбеленный цвет. Боковины могут изготавливаться на выбор из камня, кожи или шпонированного дерева.

##### ТУМБЫ С ЯЩИКАМИ

Тумбы с ящиками из коллекции One комплектуются каркасом из черного мелamina толщиной 18 мм, стеновыми и фронтальными панелями из дерева и столешницей с 3 вариантами отделки: камень, дерево или обтяжка кожей. Выдвижные шукки кухонного типа оснащены направляющими с амортизированным возвратом, элегантными металлическими бортиками антрацитового цвета, дном и стеновой панелью из черного мелamina; предусмотрена система одновременного закрытия 3 или 4 ящиков и антипрокидывать. Версия с картотечным выдвижным ящиком изготавливается только под заказ. Тумбы с выдвижными ящиками оснащаются 4 поворотными колесиками

##### Оформление

и украшены элегантными ручками из хромированного металла.

##### КНИЖНЫЕ ШКАФЫ

Отделки книжных шкафов аналогичны отделкам письменных столов и дополнительных модулей. Представляют собой шкафики, укомплектованные открытыми нишами и стеклянными либо меламиновыми полками и придодные над полом при помощи панельных боковин из дерева, камня или кожи. Створки с системой плавного закрывания, которые могут комплектоваться замками, являются опциональными и выполняются из шпона из древесины ореха, окрашенного в натуральный, табачный либо винтажный выбеленный цвет. 3 варианта отделки столешниц и боковин: камень, дерево или кожа с шитьем вандикю. Полка-надстройка опирается на распорки из камня, дерева или кожи.

##### ШКАФЫ

Модульные шкафы с разнообразными вариантами компоновки, ширина 90 см, высота 80 - 120 - 160 - 200 - 240 - 280 см Верхняя столешница отделана по всей ширине; толщина составляет 19 мм, выполнена из окрашенной древесины ореха; три варианта отделки, аналогичные отделкам письменного стола. Створки на шарнирах с углом открытия 110°, с механизмом мягкого закрывания. Помимо отделки деревом створки могут выполнятся из прозрачного закаленного стекла шириной 4 мм, с рамой из глянцевого алюминия. Картотечные выдвижные ящики скрыты створками, опираются на раму из окрашенной стали, передегаются по шариковым телескопическим направляющим, серийная комплектация механизмом мягкого закрывания и системой против опрокидывания. Замки в виде полухраповых защелок, которые не предусмотрены для стелкляных створок. Внутренние полки из кашированного мелamina толщиной 25 мм, стеновые панели толщиной 8 мм с отделкой, аналогичной отделке боковин, для возможной установки в центре комнаты. Шкафы на опорных ножках, регулируемых изнутри; боковины могут соединятся в линейку с другими шкафами. Изображений безопасности все шкафы с картотечными выдвижными ящиками, используемые по отдельности, должны крепиться к опорной стене.

##### ПРЕДМЕТЫ ОБСТАНОВКИ

В соответствии с фирменной чертой стиля Co-dutti линейка Directionale One включает в себя ряд комплектоущих, которые элегантно сочетаются с характеристиками коллекции. Металлические детали имеют хромированное покрытие либо изготавливаются из полированной зеркальной нержавеющей стали, со вставками из пьезантинского камня. Предлагается обширная цветовая гамма светильников с абажурами, оттенки которых идеально сочетаются с кожей, использованной в коллекции. В качестве альтернативы могут использоваться комплектоующие из линейки Attiva, которые также великолепно комбинируются с линейкой One.

## One

##### ATTENZIONE

Le cuciture del cuoio e della pelle possono presentare irregolarità nel tratto e variazioni di linea. Lievi imperfezioni, così come eventuali leggere sfumature nel tono del colore e nella texture del cuoio, devono essere accettate quale segno dell'unicità e della cura artigianale del prodotto.

##### ATTENTION

The stitching in both thick and thin leather may appear irregular. Slight imperfections, as the difference in the shade of color and in the texture of the leather, are the natural consequence of the craftsmanship involved in the manufacturing process, which makes each product unique.

##### ATTENTION

Les coutures du cuir et de la peau peuvent présenter des irrégularités le long de la ligne et dans les variations de la ligne même. De légères imperfections, ainsi que des éventuelles nuances du ton de la couleur et de la texture du cuir, doivent être considérées comme des signes de l'unicité et du soin artisanal du produit

##### ATENCIÓN

En las costuras del cuero y de la piel pueden aparecer irregularidades en el tramo y variaciones en la línea. Ligeras imperfecciones y posibles ligeros matices en el tono del color y en la textura del cuero, deben aceptarse como indicación de unicidad y cuidado artesanal del producto.

##### Внимание

Строчка кожаных изделий может быть неравномерной в стежках. На коже возможны большие дефекты, незначительные различия в интенсивности цвета, оттенка и текстуре кожи. Это естественное свойство изделий из натурального кожи. Эти природные метки придают особый шарм и подчеркивают натуральность покрытия мебели, без каких либо дополнительных химических обработок.



